



Fume Extraction Catalog

MIG Guns, Robotics, Fume Extraction Units, & More



xFUME® Fume Extraction Welding Guns

Air and Water-cooled



Features in Detail:

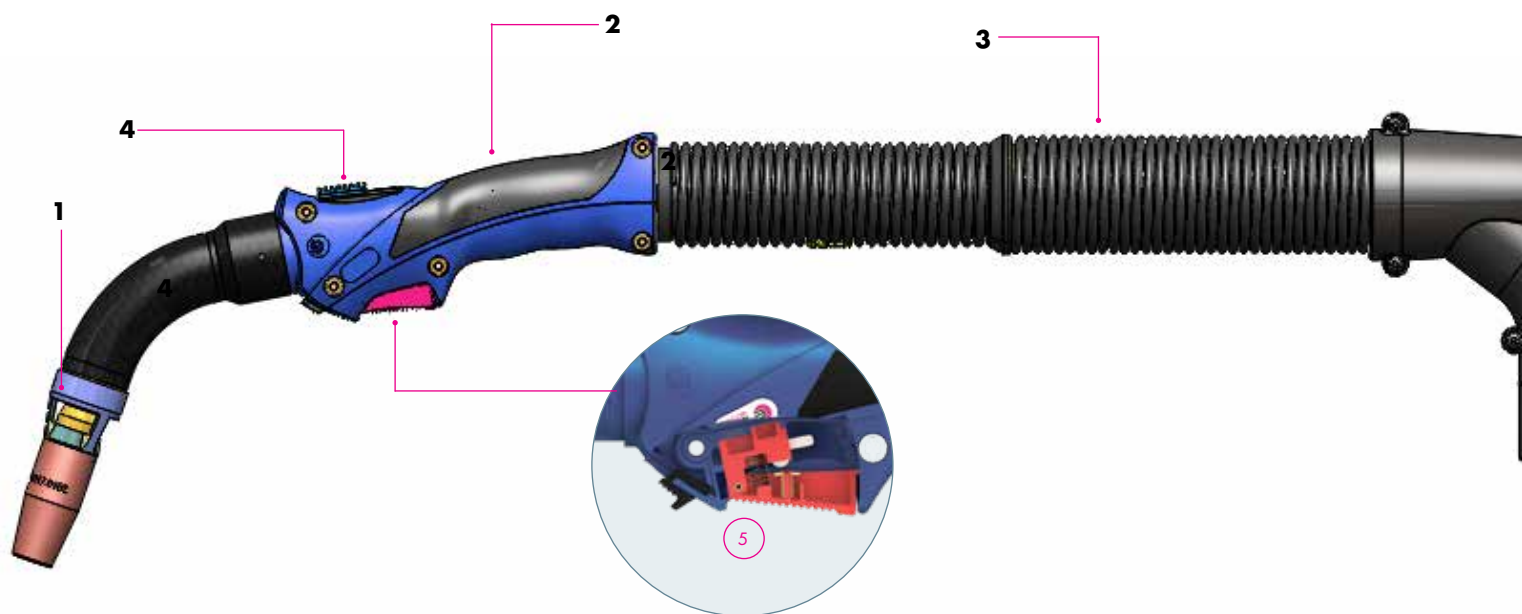

1:
Fume Nozzle (Shroud)
Tapered: Provides better accessibility.
Reverse Suction: Provides better smoke extraction especially in vertical/overhead welding positions.
Classic, slip-on consumables also available.

2:
Rubberized Grip Insert
Operator comfort and control

3:
Light Weight Cable
Reduced operator fatigue

4:
External air regulation
Ergonomically placed

5:
Completely encapsulated mechanical trigger
Optimum protection against contamination from welding fume particles

Ordering Chart

FG	3	15	H -	35	L
Amp		Cable Length	Fume Nozzle (Shroud)	Wire Size	Back End
FG - Fume Extraction Gun					
Amperage 2 - 250 Amp (Air-cooled) 3 - 300 Amp (Air-cooled) 5 - 500 Amp (Water-cooled)					Back End E - Euro HT - Tweco 4 L - Lincoln Ext Gas L1 - Lincoln 10, 74 & 84 Series L2 - Lincoln Power MIG M - Miller
Cable Length 10 - 10 Feet 12 - 12 Feet 15 - 15 Feet					Wire Size 35 - .035 Inches 45 - .045 Inches 52 - .052 Inches 62 - .062 Inches
Fume Nozzle (Shroud) H - High-flow Threaded (60° Swanneck) HR - High-flow Threaded Reverse Suction (60° Swanneck) S - High-flow Slip-on (60° Swanneck)					

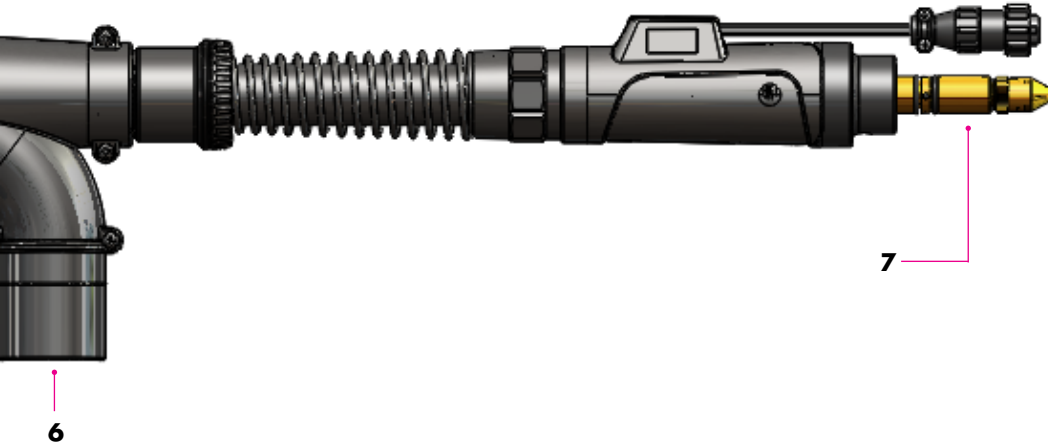

6:
Optimized cable assembly
 Due to the optimized cable assembly components, as well as an increased cross section, the flow volume increased by 20% for cooler wear parts and longer life.

7:
Machine-side connection
 Direct mount to feeder or Euro connection.

xFume® Competitive Comparison

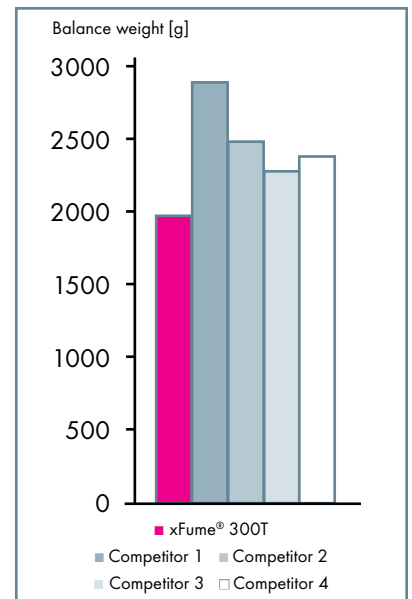

Up to 27 percent less balance weight in comparison to competitors.

xFUME® Fume Extraction Welding Guns

Air and Water-cooled

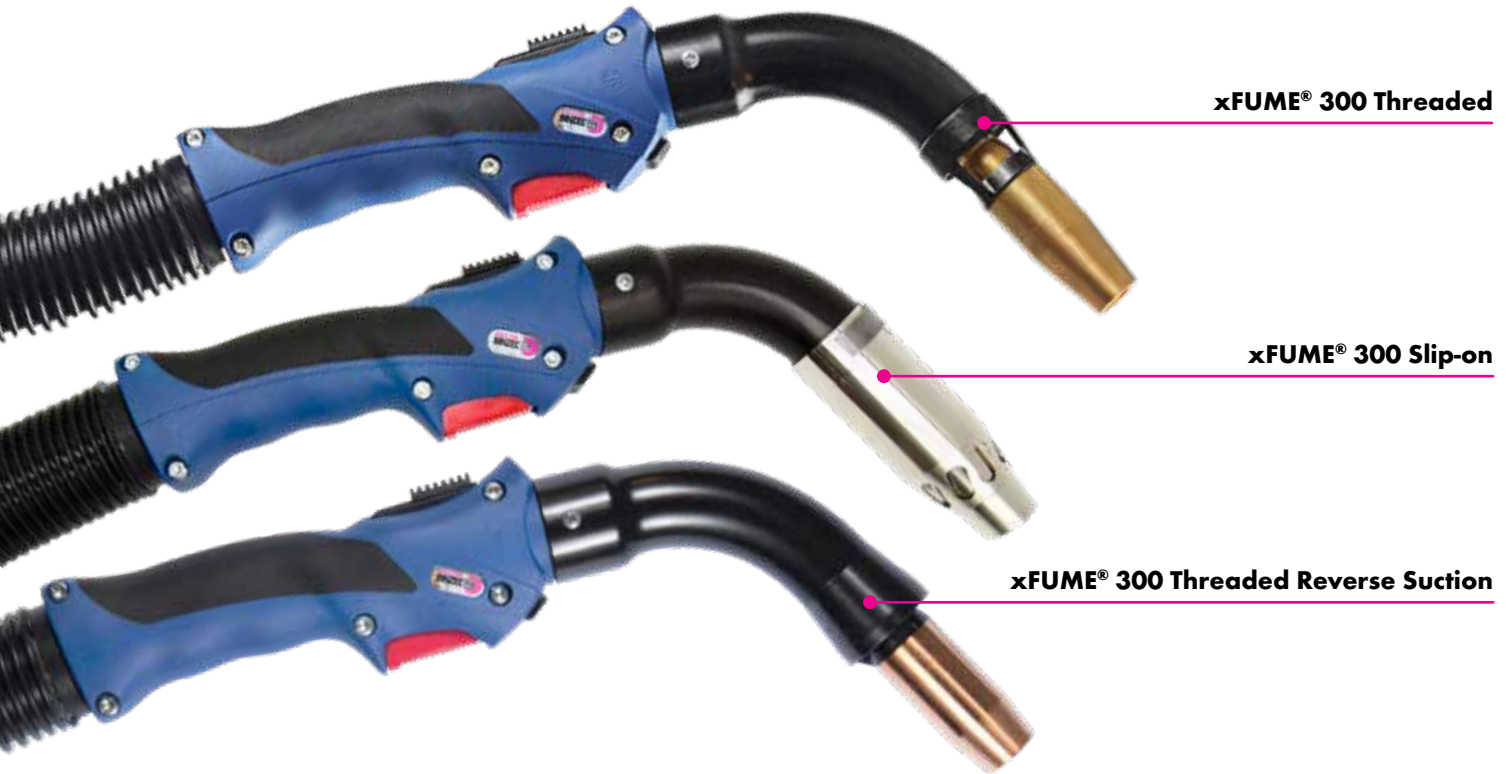

Technical data	Type	Cooling	Rating		Duty cycle (%)	Wire-Ø	
			CO ₂	Mixed Gases		(inches)	(mm)
	xFUME® 250	air	250 A	220 A	60	.030" - .045"	0.8 - 1.2 mm
	xFUME® 300	air	300 A	270 A	60	.030" - .062"	0.8 - 1.6 mm
	xFUME® 500	water	500 A	450 A	100	.035" - .062"	0.9 - 1.6 mm

*Hint for liquid cooled torches: To protect the cable assembly components against overheating, we recommend a post cooling time of at least four minutes.

Consumables

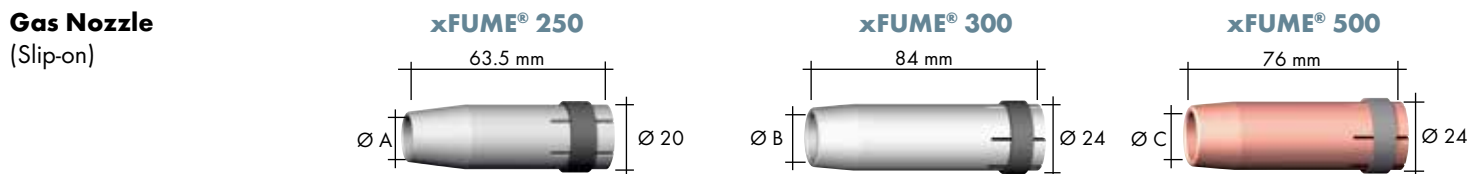
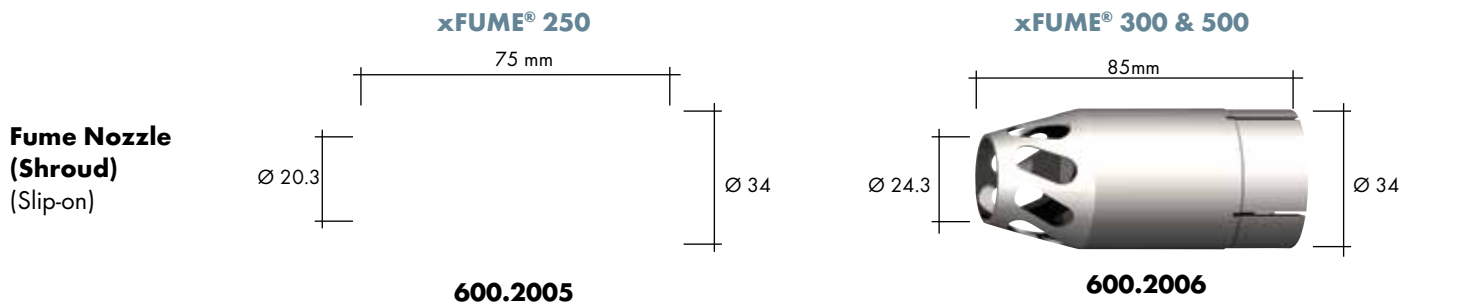

Part Nos. (Slip-on)	Nozzles		Ø A		Ø B		Ø C	
	Cylindrical		Ø 17	145.0047	Ø 19	145.0045	Ø 20	145.0051
	Conical		*Ø 12.5	145.0080	*Ø 16	145.0078	*Ø 16	145.0085
	Conical		Ø 10	145.0128	Ø 12	145.0126	Ø 14	145.0132

Wear Parts

xFUME® 250

xFUME® 300 & 500

Fume Nozzle (Shroud) (Threaded)

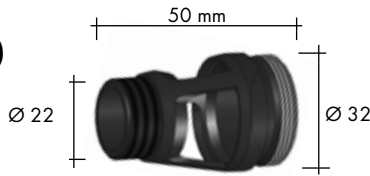

284.1061
Standard

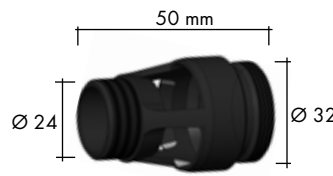

284.0734
Standard ("H" Option)



600.0116
Standard ("HR" option)

Gas Nozzle (Threaded)

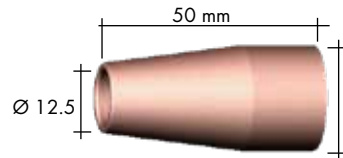

317.0106

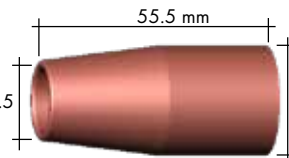

317.0102



317.0369

Part Nos. (Threaded)	Nozzles	xFUME® 250		xFUME® 300 & 500	
		Tapered	317.0106*	-	317.0102*
	Cylindrical	317.0215	-	317.0214	-
Fume Shrouds					
	Heavy-Duty Black Steel	284.1061	-	284.0734	-
	Reverse Suction Steel	284.2017	-	600.0116	-



***M6**

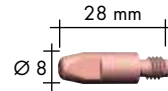

M6



***M8**

Contact tip (25 pcs.)	Material	Tip Size	xFUME® 250		xFUME® 300 & 500	
E-CU*		Ø .030"	140.0051	-	140.0051	140.0114
		Ø .035"	140.0169	-	140.0169	140.0214
		Ø .040"	140.0242	-	140.0242	140.0313
		Ø .045"	140.0379	-	140.0379	140.0442
		Ø .052"	-	-	140.0516	140.0533
		Ø .062"	-	-	140.0555	140.0587
		Ø .078"	-	-	-	-
		Ø .094"	-	-	-	-
CuCrZr		Ø .030"	140.0054	-	140.0054	140.0117
		Ø .035"	140.0172	-	140.0172	140.0217
		Ø .040"	140.0245	-	140.0245	140.0316
		Ø .045"	140.0382	-	140.0382	140.0445
		Ø .052"	-	-	140.0519	140.0536
		Ø .062"	-	-	140.0558	140.0590
		Ø .078"	-	-	-	-
		Ø .094"	-	-	-	-
Silver		Ø .030"	147.0054	-	147.0054	147.0117
		Ø .035"	147.0172	-	147.0172	147.0217
		Ø .040"	147.0245	-	147.0245	147.0316
		Ø .045"	147.0382	-	147.0382	147.0445
		Ø .052"	-	-	147.0519	147.0536
		Ø .062"	-	-	147.0558	147.0590
		Ø .078"	-	-	-	-
		Ø .094"	-	-	-	-

*Designates factory standard

xFUME® Fume Extraction Welding Guns

Tip Holders, Diffusers and Liners

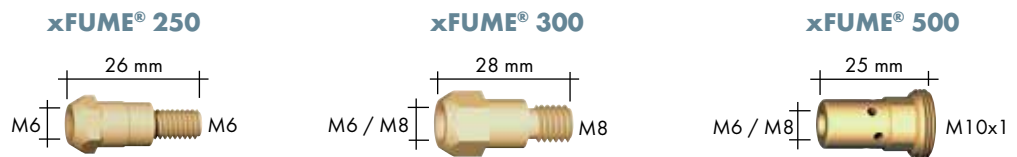

Contact tip holder (10 pcs.)

	xFUME® 250	xFUME® 300	xFUME® 500
M6	*142.0003	142.0005	142.0008
M8	-	*142.0020	*142.0022



Gas diffuser w/o-ring (10 pcs.)

	xFUME® 250	xFUME® 300	xFUME® 500
Standard	012.0407*	014.0624*	284.1821*
High Temp (Black)	-	014.0663	-

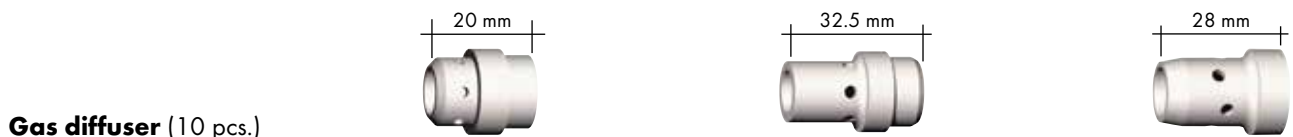

Gas diffuser (10 pcs.)

	xFUME® 250	xFUME® 300	xFUME® 500
Standard	012.0183	014.0261	030.0145
High Temp (Black)	-	014.0026	030.0037



Liners for steel wires

	xFUME® 250	xFUME® 300	xFUME® 500
Insulated steel liner 17' .024"-.035"	124.0015	124.0015	-
Insulated steel liner 17' .035"-.045"	124.9042	124.9042	-
Insulated steel liner 17' .052"-.062"	-	124.9043	-
Uninsulated steel liner 17' .035"-.045"	-	-	122.9057
Uninsulated steel liner 17' .052"-.062"	-	-	122.9058



Liners for stainless wires

	xFUME® 250	xFUME® 300	xFUME® 500
Liner C-TFE 024"-030" 12' (for 10' gun)	127.9007	127.9007	127.9007
Liner C-TFE 024"-030" 17' (for 12' & 15' gun)	127.9009	127.9009	127.9009
Liner C-TFE 035"-045" 12' (for 10' gun)	127.9001	127.9001	127.9001
Liner C-TFE 035"-045" 17' (for 12' & 15' gun)	127.9003	127.9003	127.9003
Liner C-TFE 052"-062" 12' (for 10' gun)	-	127.9004	127.9004
Liner C-TFE 052"-062" 17' (for 12' & 15' gun)	-	127.9006	127.9006

Liner parts

	xFUME® 250	xFUME® 300	xFUME® 500
Liner C-TFE - 024"-030" Bulk	125.0005	125.0005	125.0005
Liner C-TFE - 035"-045" Bulk	125.0007	125.0007	125.0007
Collet Plastic Liner - 024"-045"	131.0001	131.0001	131.0001
Collet Plastic Liner - 052"-078"	-	-	131.0002
O-Ring 3.5X1.5mm	165.0008	165.0008	165.0008
Euro Liner Support for small PA Liners (See LIT.9039)	**129.xxxx	**129.xxxx	**129.xxxx

*Designates factory standard.

**Length varies depending on central adapter p/n, see LIT.9039

xFUME® Fume Extraction Welding Guns

Accessories

Weld Cable Cover



Features & Benefits

- 1000 Denier Cordura with flame retardant coating
- Extremely lightweight
- Continuous temp rating: +250°F
- Momentary temp rating: 800°F
- Excellent UV protection
- Unaffected by water, oils, and mild solvents
- Excellent resistance to abrasion, weld spatter, puncture and tear resistance

Ordering Instructions for Protective Cable Covering

WC	-	1.0	-	BULK
Model		Diameter Selection		Length
Model				Length
Weld Cover				Sold Per Meter*

Diameter Selection

1.0 = 1" ID

2.0 = 2" ID

2.25 = 2 -1/4" ID

2.38 = 2 -3/8" ID (2.38" cover fits the 38mm OD front fume hose well and is tight on the larger 45mm OD rear hose. See note below**)

2.5 = 2 -1/2" ID (2.50" cover fits the 38mm OD front fume hose loose and fits well on the larger 45mm OD rear hose. See note below**)

*45m = One full 150' roll

**In most applications, the 2.38" cover is preferred, but it is recommended to select 2.5" cover if flexibility is required on the rear fume hose section of the fume extraction torch. Tight hose coverings limit flexibility of the fume hose.

xFUME® Fume Extraction Welding Guns

Accessories

Anti-Spatter Ceramic Spray & Coating Cap



Ceramic Spray (p/n 192.0228.12 (12-pack))
Ceramic Spray (p/n 192.0228.1 (Single Can))

Aerosol ceramic anti-spatter coating. Thin coating creates a solid protective barrier against spatter on consumables, fixtures, and tools.

A single application lasts up to 6 hours of welding which means less downtime in both robotic and hand-held welding applications.

13.5 oz. cans sold by the case

Coating Cap (p/n 192.0256.1 (1 each))

The Ceramic Coating Cap was developed special for ABICOR BINZEL's Ceramic Spray. The tip of the gas nozzle and its interior can be protected in a few seconds from adhering welding spatter with the Coating Cap.

The Coating Cap offers cost savings through lower consumption while protecting both the welder and the environment.

Gas Flow Checker



Gas Flow Checker (p/n 191.0013 (1 each))
Metric Gas Flow Checker (p/n 191.0003 (1 each))

Ensure you're getting the proper gas flow at the nozzle. Measures 0-40 cfm. Metric gas flow checker also available (0-20 l/min).

Magnehelic Static Pressure Gauge



Magnehelic Static Pressure Gauge (p/n 284.1939)

Test various sections of your fume extraction system to ensure the optimal static pressure is being produced.

CLEAN CELL TECHNOLOGY™

Full line of fume extraction solutions to keep your robotic cell, and the surrounding area, clean and fume-free.



xFUME® Robo Over-Arm Robotic Fume Extraction Kit

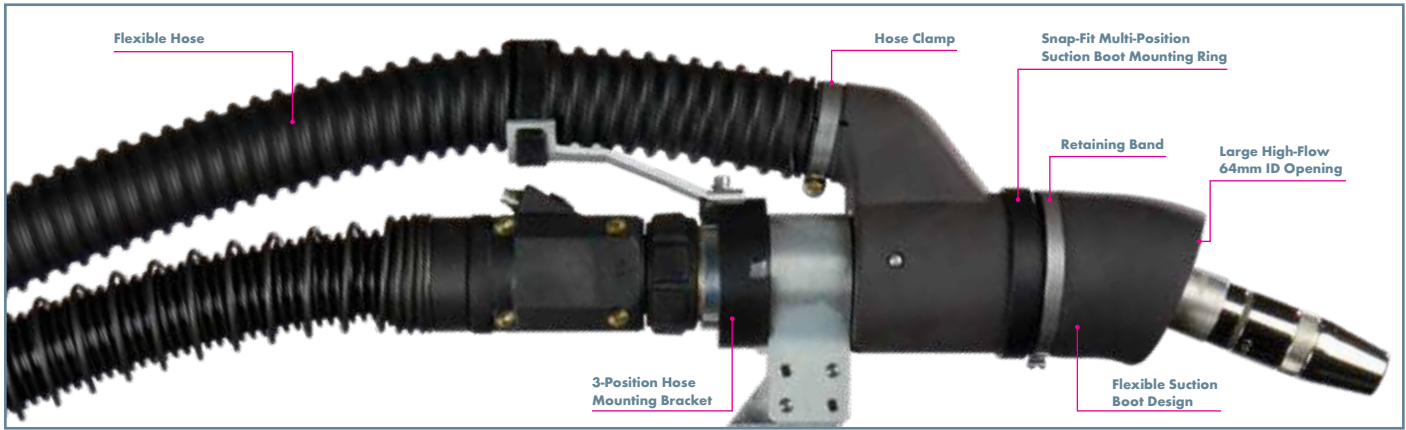

xFUME® ROBO for Over-Arm ABIROB A & ABIROB W

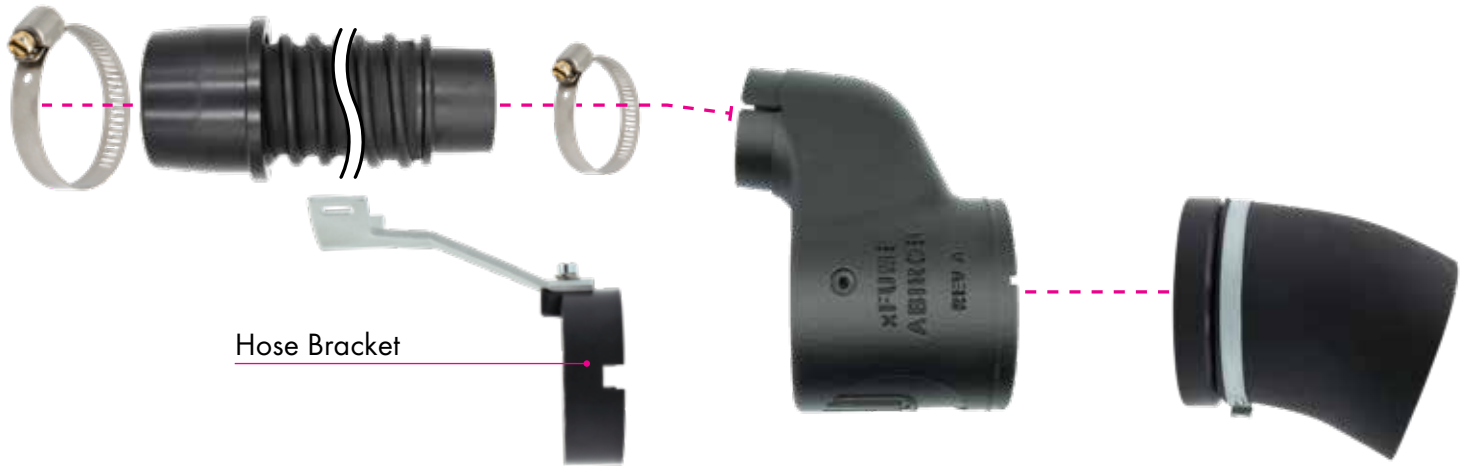

xFUME® ROBO for Over-Arm ROBO WH



Features & Benefits:

- Patent-Pending Design
- Replaceable wear parts
- 5' flexible suction hose with 50mm/2" Ø male adapter
- Flexible suction boot for improved accessibility
- Includes 2" hose clamp & two heavy duty hook-n-loop straps for hose management
- Fits onto existing ABIROB & WH torch setups
- Compatible with any fume extractor capable of 22in - w.c. min. *

**22" w.c. minimum measured at rear connection of 5' flex hose for optimal removal of fume generated using solid wires.*

xFUME® ROBO

Over-Arm Replacement Parts

Replacement parts and accessories

Pos.	Description	Part-No.
	Complete unit	See Order Chart
1	Suction Boot	See Table (pg. 15)
2	Suction Boot Mounting Ring - OA	284.1755
3	Boot Clamp	284.1827
4	Hose Clamp - Front	171.0013
5	Hose Clamp - Rear	171.0012
6	Hose Bracket	284.1856
7	5' OA Extraction Hose	284.1795
8	Housing Set Screw (ROBO WH)	009.0466
9	Housing Set Screw (ABIROB A)	009.0463
10	Housing Set Screw (ABIROB W)	009.0467
11	Hose Management Straps	CS-08HDE

xFUME® Robo Through-Arm Robotic Fume Extraction Kit

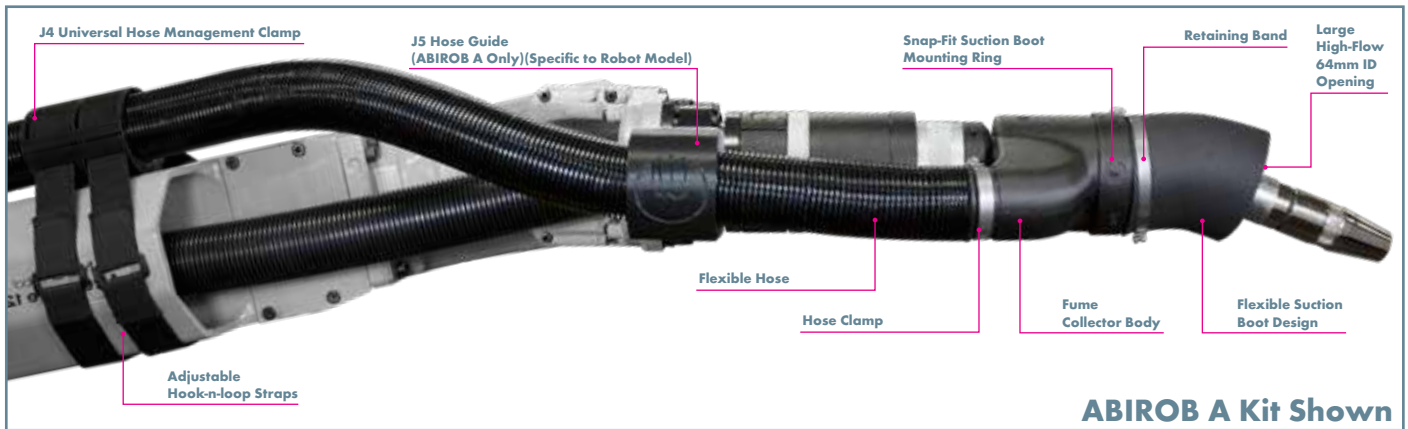

xFUME® ROBO for Through-Arm ABIROB A



xFUME® ROBO for Through-Arm ABIROB W

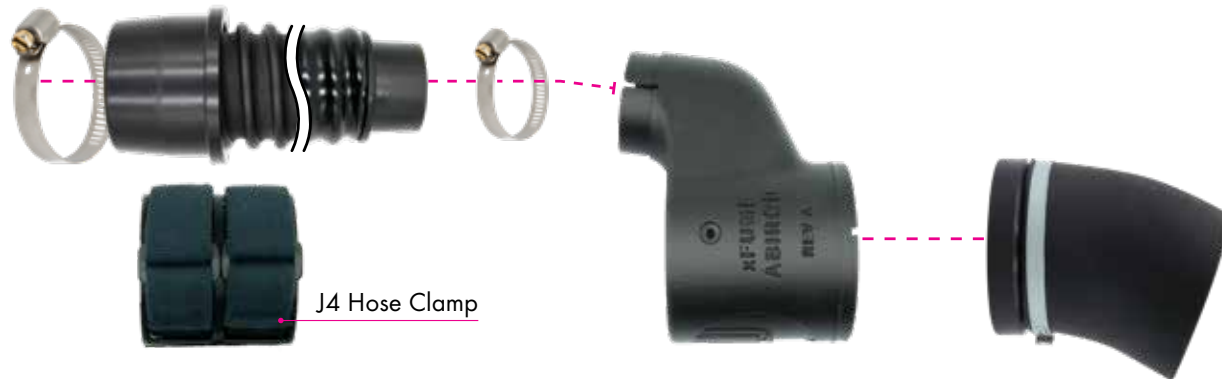

xFUME® ROBO for Through-Arm ROBO WH

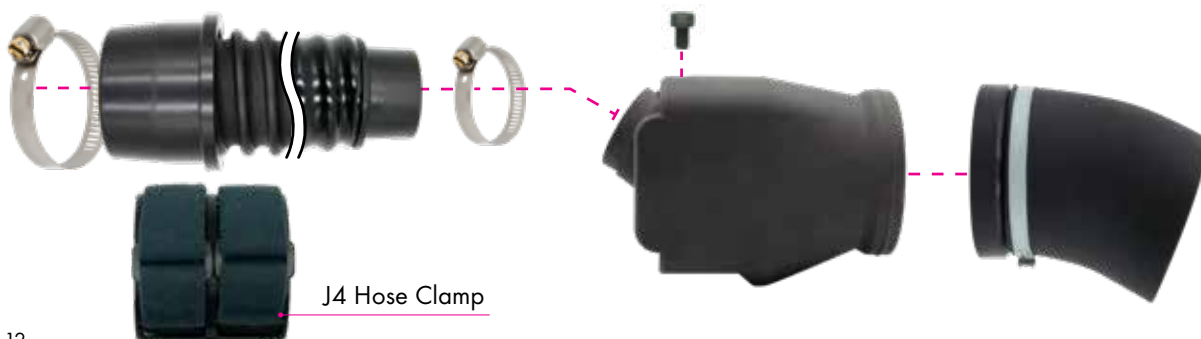

Features & Benefits:

- Replaceable wear parts
- 5' flexible suction hose with 50mm/2" Ø male adapter
- Flexible suction boot for improved accessibility
- ABIROB A kit allows for J6 axis rotation with secure, side-mounted extraction hose.
- J4 Hose management clamp with elastic hook-n-loop straps.
- Fits onto existing ABIROB & WH torch setups
- Compatible with any fume extractor capable of 22in - w.c. min.*

*22" w.c. minimum measured at rear connection of 5' flex hose for optimal removal of fume generated using solid wires.

xFUME® Robo Through-Arm Replacement Parts

Replacement parts and accessories



Pos.	Description	Part-No.
	Complete unit	See Order Chart
1	Suction Boot	See Table (pg. 15)
2	Suction Boot Mounting Ring (ABIROB A)	284.2102
	Suction Boot Mounting Ring (ABIROB W & ROBO WH)	284.1755
3	Boot Clamp	284.1827
4	Clamp - Extraction Hose Front	171.0013
5	Clamp - Extraction Hose Rear	171.0012
6	J5 Hose Guide (ABIROB A Rotational)(Robot Specific)	Contact Sales
7	5' HW Extraction Hose	284.1795
8	Housing Set Screw (ROBO WH)	009.0466
9	Housing Set Screw (ABIROB W)	009.0467
10	J4 Hose Management Clamp w/24" Straps	284.2097.1
	J4 Hose Management Clamp w/48" Straps	284.2143.1
11	Locking Neck Tab (ABIROB A)	284.2015
12	Locking Neck Tab Clamp (ABIROB A)	284.2047

xFUME® ROBO Ordering Chart

xFUME® ROBO

Ordering Instructions for xFUME® ROBO Kits

XR	-	OA	-	AB	-	1
Model		Mounting Selection		Neck Selection		Collection Boot
<p>Model</p> <p>xFUME™ ROBO</p>		<p>Mounting Selection</p> <p>OA - Over Arm Torch Mount (All Robot Models) TH6** - All TH6 Seam Tracking Applications A01 - ABB 1520iD, 1600iD A02 - ABB 1660iD, 2600iD D01 - OTC FD-B6 F01 - FANUC IC F02 - FANUC ID M01 - MOTOMAN EA/MA 1400N, 1900N, 3100 M02 - MOTOMAN MA/AR 1440, 1730, 2010, 3120 K01 - KUKA KR5, KR6, KR8, KR16-L8</p>		<p>Neck Selection*</p> <p>AB - A360 22D (980.1024) AD - A360 45D (980.1026) BB - A500 22D (980.1013) BD - A500 45D (980.1015) CB - W300 22D (782.0161) CD - W300 45D (782.0162) DB - W500 22D (782.0003) DD - W500 45D (782.0005) FB - W600 22D (782.0214) FD - W600 45D (782.0216) HB - WH500 22D (962.1549) HD - WH500 45D (962.1532) JB - WH600 22D (962.1746) JD - WH600 45D (962.1748)</p>		<p>Collection Boot</p> <p>1 - 64mm ID Collection Boot</p>

*Neck options listed are standard neck options. For custom neck solutions, please contact sales.

**Use the TH6 mounting selection for ABIROB W on Fanuc Servo Drive versions iC2 & iC3

xFUME® ROBO

Replacement Suction Boot Selection



Replacement Suction Boot Selection

Torch Series	Torch Neck	Suction Boot	Over-Arm/Hollow Wrist
A500 22D/A360 22D	980.1013/980.1024	284.1662.1	OA
A500 22D/A360 22D	980.1013/980.1024	284.1663.1	HW
A500 45D/A360 45D	980.1015/980.1026	284.1667.1	OA
A500 45D/A360 45D	980.1015/980.1026	284.1668.1	HW
W500 22D	782.0003	284.1664.1	OA/HW
W500 45D	782.0005	284.1669.1	OA/HW
W600 22D	782.0214	284.1846.1	OA/HW
W600 45D	782.0216	284.1848.1	OA/HW
WH500 22D	962.1549/962.9945.US	284.1666.1	OA/HW
WH500 45D	962.1532/962.9948.US	284.1670.1	OA/HW
WH600 22D	962.1746/962.1770	284.1850.1	OA/HW
WH600 45D	962.1748/962.1772	284.1851.1	OA/HW

Note: If your torch neck is not listed, please see the table on our website here:

www.binzel-abicor.com/US/eng/products/fume-extraction-welding/xfume-robo/ or contact Customer Service

xFUME® Advanced

Powerful Fume Extraction for Up to 2 Welding Stations



No Room for Fumes.

In combination with ABICOR BINZEL fume extraction MIG guns, the mobile extraction system xFUME ADVANCED extracts welding fumes directly at the source.

- Particularly powerful thanks to high-vacuum technology with more than 18,000 Pa (115V) / 24,000 Pa (230V) negative gauge pressure
- Two connections for extraction hoses
- Up to two work stations with one system, for flexibility and comfort.
- Automatic filter cleaning by compressed air impulse
- Highly efficient thanks to the cartridge filter, which filters out up to 99.5% of all dust > 0.1 µm
- Automatic start/stop via current clamp for reduced operating costs and less wear and tear

xFUME® Advanced

Powerful Fume Extraction for Up to 2 Welding Stations

Technical specifications

	xFUME® ADVANCED (115V)	xFUME® ADVANCED (230V)
Max. airflow:	200 CFM (340 m ³ /h)	360 CFM (610 m ³ /h)
Connections:	2	2
Airflow Performance:	118 CFM @ 40in-H ² O 84 CFM @ 55in-H ² O	150 CFM @ 60in-H ² O 100 CFM @ 80in-H ² O
Connection diameter:	2.36 in (60 mm)	2.36 in (60 mm)
Max. vacuum:	18,000 Pa	24,000 Pa
Noise level:	≤ 68 dB (A)	≤ 80 dB (A)
Voltage:	115V 50/60Hz	230V 50/60Hz
Motor power:	2 x 0.8 kW	2 x 1.6 kW
Filter efficiency:	≥ 99.5% @ 0.1 - 0.3µm	≥ 99.5% @ 0.1 - 0.3µm
Cleaning:	Automatic	Automatic
Automatic start/stop:	Yes	Yes
Adjustable air flow:	Yes	Yes
Weight:	88 lbs (40.0 kg)	118 lbs (53.5 kg)
Size:	14.6 x 14.6 x 39.3 in 370 x 370 x 1000 mm	20.9 x 14.6 x 39.3 in 530 x 370 x 1000 mm

Ideally suited with xFUME® fume extraction welding guns

Combine xFUME® ADVANCED with ABICOR BINZEL fume extraction torches for maximum effectiveness. Thanks to optimum coordination between a high-vacuum system and a high-vacuum welding gun, they ensure highly efficient extraction directly at the source with a clear view of the arc at the same time. xFUME® extraction guns can be easily connected to all existing MIG welders.



xFUME® Advanced System Overview

Features & Benefits:

- High-vacuum capacity with high static pressure removes fume more efficiently
- Up to 2 fume guns able to be connected
- Automatic filter cleaning with an easy to use compressed air impulse feature



Illustration 1:
Compressed air connection for 100% automatic cleaning

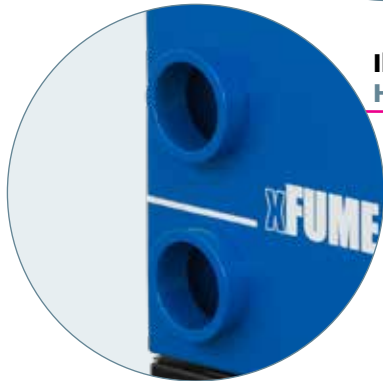

Illustration 2:
Hose connection ports for up to 2 fume extraction guns



Illustration 1:
Compressed Air Connection
3/8" Industrial quick-disconnect for optimal filter cleaning

Illustration 2:
Hose Connection Ports
60mm inlet ports for direct hose-cuff connection

Illustration 3:
Motors
Dual vacuum motors w/replaceable brushes for peak vacuum performance

- Up to 99.5% particle retention from 0.1 - 0.3µm
- Compact and easy to transport around the shop floor
- Automatic start/stop function



Illustration 3:
Control box with
2 x 0.8 kW motors (115V)
2 x 1.6 kW motors (230V)



Illustration 4:
Control Panel



Illustration 5:
Dust collection bin for easy metal removal



Illustration 4:
Control Panel

Simple on/off, auto/manual, and speed controls w/power indicator, service lights, hour meter, and two shunt receptacles

Illustration 5:
Dust Collection Bin

Slide-out tray w/threaded fasteners for easy installation and maintenance.

xFUME® Advanced

Part Numbers & Replacement Parts

Complete extraction unit



Extraction unit package includes:

- (1) Extraction hose with hose cuffs, L = 5m (16')
- (1) Start/stop shunt
- (2) Cartridge filters
- (1) 3/8" industrial quick-disconnect air fitting
- (1) Filter wrench

Note: Additional extraction hose and start/stop shunt purchased separately to operate the extraction unit with two torches.

Replacement parts and accessories



Pos.	Description	Part-No.
1	Complete unit xFUME ADVANCED (115 V, 60 Hz)	601.0128.1
2	Complete unit xFUME ADVANCED (230 V, 60 Hz)	601.0121.1
3	3/8" Industrial Air Connection	284.1814
4	Filter Cartridge (HISTEC PTFE)*	601.0111
5	Vacuum Port Seal	601.0114
6	Star-Handled Screw for Dust Collection Bin	601.0115
7	Extraction Hose (Complete) - 5m (16')	601.0117.1
	Extraction Hose Cuff	601.0116.1
8	Air Connection Adapter	601.9105.US
9	Quick-Lock Latch	601.0120
10	Auto Start/Stop Shunt	601.0041
11	(1) Motor - 1.6 kW (230V)	601.0122.1
12	Carbon Brushes - 1.6 kW	601.0129.1
13	(1) Motor - 0.8 kW (115V)	601.0110
14	Carbon Brushes - 0.8 kW	601.0118

* Standard filter for xFUME ADVANCED



xFUME® Flex

The mobile all-rounder for fume extraction



Start Strong.

The mobile extraction unit xFUME® FLEX is versatile and always the right choice when an effective and flexible extraction system is required for bench work or TIG welding.

- Freely movable extraction funnel with 2, 3 or 4 meter extraction arm for easy, precise placement
- Compact, lightweight and movable design for mobile use and easy transport
- Durable, low-maintenance brushless motor
- Easy handling thanks to easily replaceable disposable filter
- Integrated LED lighting for optimum lighting conditions even with narrow workpieces
- Simple "plug & play" installation

Technical specifications

Max. airflow:	xFUME® FLEX 700 CFM (1200 m ³ /h)
Connections:	Extraction arm
Vacuum Hose diameter:	6 in
Filter Area:	387 sq-ft
Noise level:	≤ 72 dB (A)
Voltage:	115 V 50/60 Hz
Motor power:	1.1 kW
Filter efficiency:	≥ 99.95 % @ 0.1 - 0.3 μm
Cleaning:	None
Automatic start/stop:	No
Adjustable air flow:	No
Weight:	306 lbs (139.0 kg)
Size:	27.5 x 27.5 x 45.5 in 700 x 700 x 1115 mm

Ideally suited with ABIMIG air or water-cooled welding guns

Combine xFUME® FLEX with ABICOR BINZEL's leading ABIMIG® welding guns - available in air and water-cooled models ranging from 200A-600A. ABIMIG® features a universal, slim handle design with optional swanneck bends and lengths for the toughest welding joint to access. ABIMIG® AT/WT are our industry-best lightweight MIG torch, for comfortable welding all day long.



xFUME® Flex System Overview

xFUME® Flex Features & Benefits:

- 387 ft² cassette-style filter
- 2m, 3m, and 4m extraction arms available



Illustration 1:
Suction hood with
integrated LED lighting
and protective grids

Illustration 2:
Durable, locking castors
make for easy portability

Illustration 1:
Suction Hood w/LED
Optimized suction hood
w/grab handle and integrated
LED light

Illustration 2:
Locking Castors
6in locking castors for easy mobility
using the integrated grab bar

Illustration 3:
Easy Filter Replacement
H-13 rated cassette-style filter w/
pre filter for rapid filter changes

- 115V/60Hz Power
- Industry leading filter efficiency of 99.95% @ 0.1 - 0.3 μ m
- Energy efficient 1.1kW brushless motor for long service life

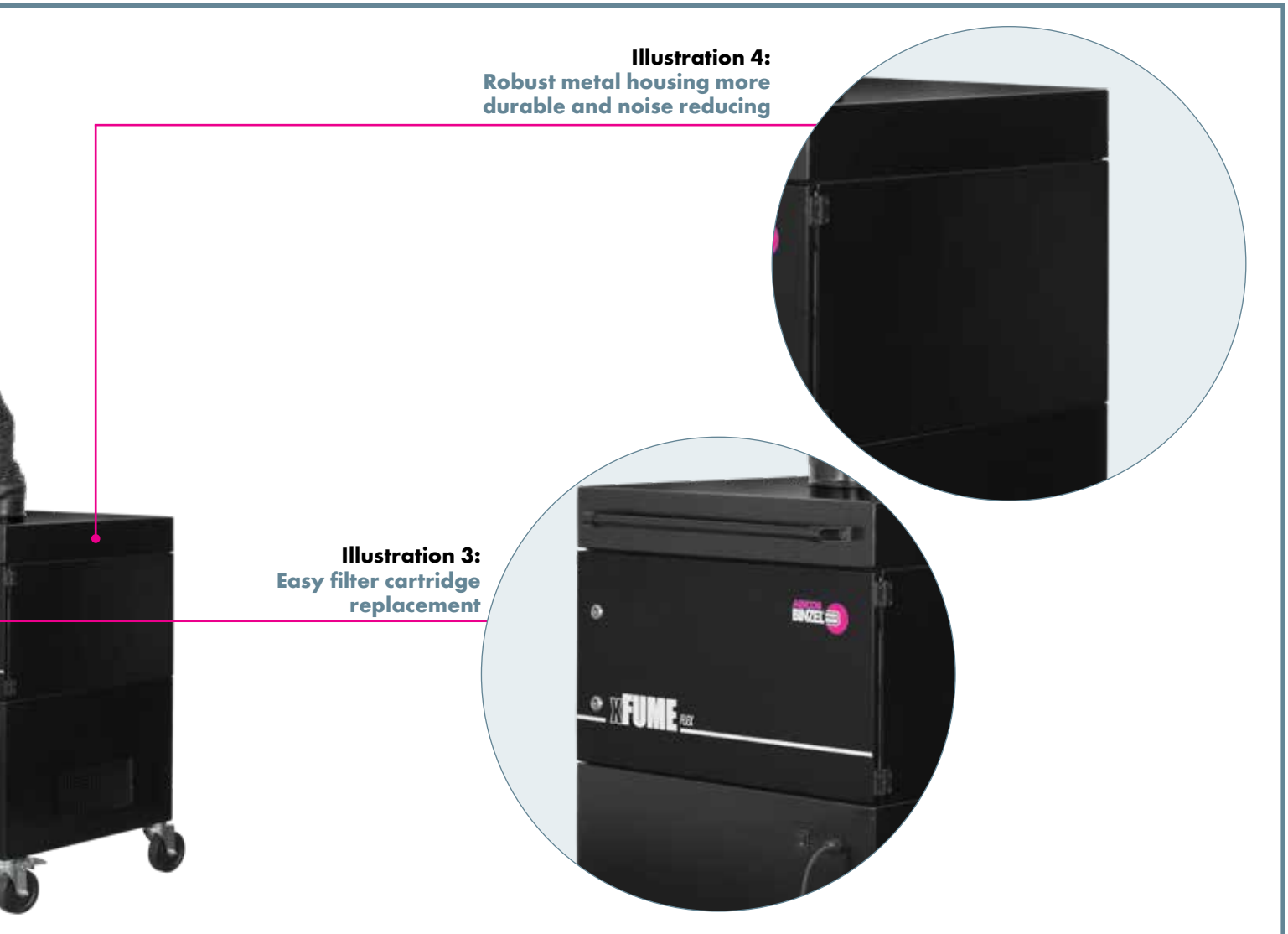

Illustration 4:
Robust metal housing more durable and noise reducing

Illustration 3:
Easy filter cartridge replacement

Illustration 4:

Robust Metal Housing

Powder coated sheet metal constructed for maximum durability

xFUME® Flex

Part Numbers & Replacement Parts

Complete extraction unit



Extraction unit package includes:

- (1) Extraction arm w/hose (2m, 3m, or 4m)
- (1) Extraction hood with integrated LED light
- (1) Filter cartridge + (1) Pre-Filter

Replacement parts and accessories

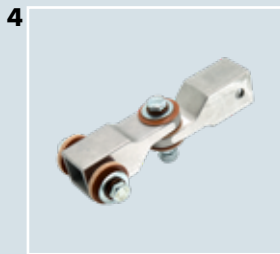
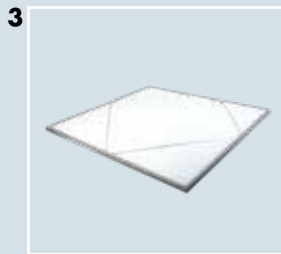

Pos.	Description	Part-No.
1	Complete unit xFUME FLEX (2m) Complete unit xFUME FLEX (3m) Complete unit xFUME FLEX (4m)	601.0123.1 601.0124.1 601.0125.1
2	Filter Cassette H13 Glass Fiber	601.0112.1
3	Pre-Filter Synthetic Non-Woven Pad	601.0119.1
4	Joint Elbow Arm/Hood	601.0164.1
5	Extraction Arm w/o Hood - 2m Extraction Arm w/o Hood - 3m Extraction Arm w/o Hood - 4m	601.0165.1 601.0166.1 601.0167.1
6	Extraction Hood w/LED/Grill	601.0168.1
7	Rubber Hose Seal/Cover	601.0169.1
8	Extraction Hose/Duct - 2m w/ (2)601.0169.1 Extraction Hose/Duct - 3m w/ (2)601.0169.1 Extraction Hose/Duct - 4m w/ (2)601.0169.1	601.0170.1 601.0171.1 601.0172.1



Fume Extractor Unit IndustriFume™

For 4 or More Fume Extraction Stations - Manual or Robotic!



Power and Precision for Fume Extraction Welding.

IndustriFume is designed to fit 4 or more fume extraction welding guns or kits and captures up to 99.97%* of harmful welding fumes emitted in plants every day. Use IndustriFume with a variety of flexible hose packages or hard duct the IndustriFume to a fixed position.

- Fit 4 to 6 fume extraction welding guns or kits to a single unit for increased space efficiency
- Powerful motor and sturdy design reaches a high static pressure to capture fumes even at high parameters
- User-friendly setup lets you use flexible hoses or hard ducting to meet your operating needs
- Variable Frequency Drives provides unique control capabilities

*Captures up to 99.97% of particles w/optional HEPA exhaust filter

Technical specifications

Open airflow:	IndustriFume® 710 CFM (1207 m ³ /h)
Connections:	Single 5" port for duct system (standard) 4-port plenum plate (optional) 6-port plenum plate (optional)
Electrical requirements: (All options 3-Phase)	208* - 230V/460V/575V
Compressed air requirement:	70 - 90 PSI (4.8 - 6.2 bar) 0.25 inch industrial quick connect
Noise level:	≤ 75 dB (A) at 5 ft
Filter:	MERV15 Flame Retardant Nano Fiber 275 ft ² E11 Flame Retardant PTFE 100% Spun-bond Polyester 273 ft ²
Motor power:	28 HP
Filter efficiency* *:	≥ 85% - 95% @ 0.1 - 0.3µm ≥ 99.97% @ 0.1 - 0.3µm (w/optional HEPA exhaust filter)
Cleaning:	automatic
Filter area:	273 - 275 ft ²
Automatic start/stop:	Yes
Adjustable air flow:	Yes
Weight:	Approx. 1166 lbs. (529kg)
Size:	62 x 31 x 71 in 1575 x 787 x 1803 mm

* Performance specs based on 230V; Reduced max performance on 208V

** Filter efficiency dependent on the choice of filter. For more information please contact us for a consultation.

Ideally suited for xFUME® fume extraction weld solutions



IndustriFume fume extractor units are made to be used with Manual or Robotic fume extraction solutions. Pair up the IndustriFume with ABICOR BINZEL fume extraction guns like the xFUME®, or use with the revolutionary xFUME® ROBO robotic fume extraction kits - available for ABICOR BINZEL robotic MIG guns in through-arm or over-arm styles.



Fume Extractor Unit IndustriFume™ System Overview

IndustriFume Features & Benefits:

- Automatic start/stop function with Economizer Shunt
- Up to 275ft², vertically positioned filter
- Automatic filter cleaning with programmable pulse controller



Illustration 1: Automatic Filter Cleaning

Reach maximum filter service-life through automatic filter cleaning with the programmable pulse controller. A differential pressure sensor is used to actively monitor filter condition and perform automatic cleaning cycles without interrupting operation. A pulse-air reservoir is used for maximum efficiency. When necessary, filter changes can be completed quickly and easily with a tool-less clamping design.

Illustration 2: Heavy Duty Construction

The IndustriFume units are built to last, utilizing 10 & 12-gauge steel construction with built-in acoustical lining and corrosion-resistant aluminum blower housing, impeller and cover. It is powered by a 28 HP motor with permanently sealed ball bearings and thermal overload protection.

- Replaceable spark arrestor
- 3-Phase 208/230V, 460V or 575V power supply options
- Up to 95% fume removal depending on filter choice
- Up to 99.97% w/optional HEPA exhaust filter



Illustration 3:
NEMA-12 Electrical Enclosure
 Electronics, including the variable frequency drive and the AutoPulse controller, are housed in a NEMA-12 electrical enclosure. The disconnect switch, start/stop button, and AutoPulse controller interface are easily accessible from the front panel.

Illustration 4:
Variable Frequency Drive
 The operation of the Industrifume unit is efficient with automatic, demand based, start/stop using the Economizer® shunt, performance tuned soft-start and programmable Sleep-Mode all through the onboard variable frequency drive. Manage blower speed for reduced dust impaction and improved cleaning cycles.

Fume Extractor Unit IndustriFume™

Replacement Parts

Complete extraction unit



- Extraction unit package includes:**
- Economizer® Auto Start/Stop Shunt
 - 1 Filter cartridge (2 Options)
 - Replaceable Spark Arrestor

Replacement parts and accessories

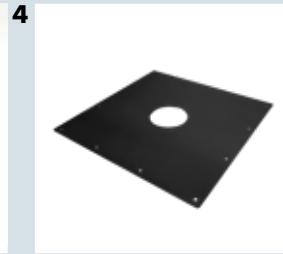

Pos.	Description	Part-No.
1	Complete unit	See Order Chart
2	2" 6-Port Plenum Plate Assembly (Optional)	284.1709
3	Adapter Sleeve Vacuum Tube 2"Ø	284.1689
4	5" Single Opening Plenum Plate (Standard)	284.1685
5	Pulse Valve	284.1691
6	Door Gasket (Cut to Length)	284.1687
7	Economizer® Auto Start/Stop Shunt	284.1686
8	MERV15 Nanofiber Filter	284.1698
8	E11 PTFE 100% Polyester Filter	284.1699
9	HEPA Exhaust Filter (Optional)	284.2033

Ordering Chart

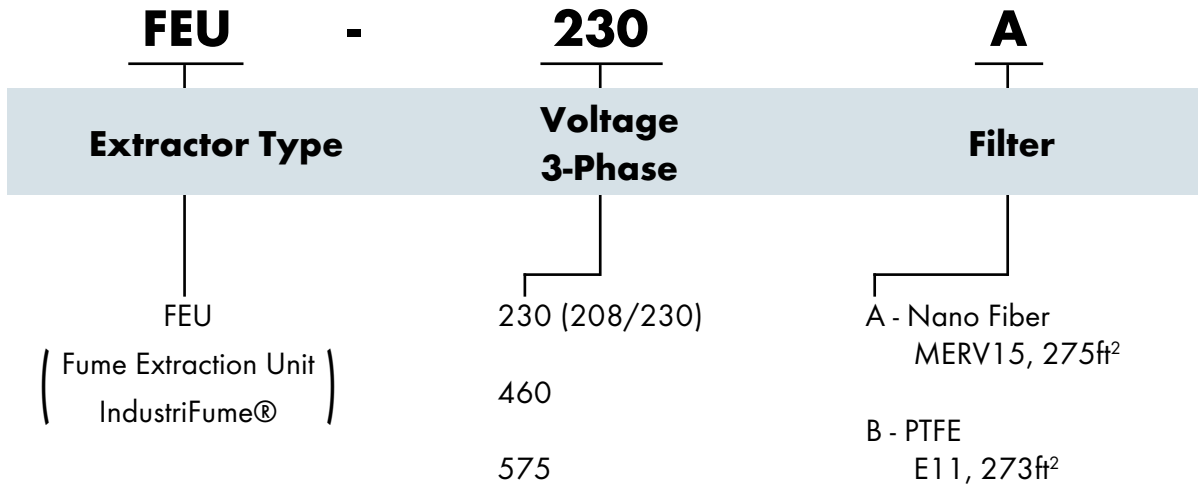



ABICOR BINZEL USA, Inc.
650 Medimmune Court, Suite 110
Frederick, MD 21703
Phone: 800.542.4867
Fax: 301.846.4497
E-Mail: customerservice@abicorusa.com

www.binzel-abicor.com